

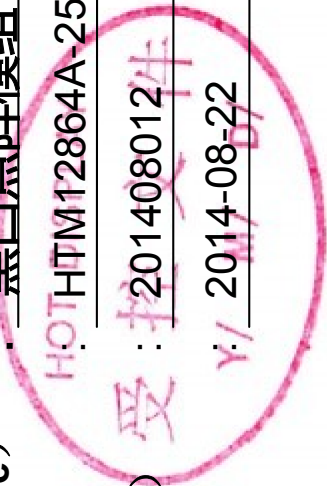

HTM12864A-25W-N5P

产品名称 (Product name) : 黑白点阵模组
 型号 (Model) : HOT HTM12864A-25W-N5P
 编号 (Part number) : 201408012
 日期 (Date) : 2014-08-22



深圳市鑫洪泰电子科技有限公司 Shenzhen Hot Display Technology Co.,Ltd		
编制	审核	核准
Prepared by	Checked by	Approved by
<i>[Signature]</i>	<i>[Signature]</i>	<i>[Signature]</i>

编码: QR-R-011 A/0

序号:

Rev.	Descriptions	Date
01	Prelimiay Release	2014-08-22



鑫洪泰

HOT DISPLAY 为您提供专业的显示解决方案

HTM12864A-25W-N5P

Table of Content

1. Basic Specifications	-----	3
1.1 Display Specifications	-----	3
1.2 Mechanical Specifications	-----	3
1.3 Circuit Diagram	-----	3
1.4 Terminal Function	-----	4
1.5 Product Outline	-----	5
1.6 Schematic Diagram	-----	6
2. Absolute Maximum Ratings	-----	7
3. Electrical Characteristics	-----	7
3.1 DC Characteristics	-----	7
3.2 LED Backlight Circuit	-----	7
3.3 AC Characteristics	-----	8
3.4 Reset Timing	-----	9
4. Function specifications	-----	10
4.1 The Parallel Interface	-----	10
4.2 Display Memory Map	-----	10
4.3 Display Commands	-----	11
4.4 Basic Operating Sequence	-----	12
5. Inspection Standards	-----	13
6. Handling Precautions	-----	14
6.1 Mounting method	-----	14
6.2 Cautions of LCD handling and cleaning	-----	14
6.3 Caution against static charge	-----	14
6.4 Packaging	-----	14
6.5 Caution for operation	-----	14
6.6 Storage	-----	14
6.7 Safety	-----	14
7 Packaging specifications	-----	15

1. Basic Specifications

1.1 Display Specifications

- 1>LCD Display Mode : STN-Bule, Negative, Transmissive
- 2>Viewing Angle : 6H
- 3>Driving Method : 1/64 Duty, 1/9 Bias
- 4 >Backlight : White

1.2 Mechanical Specifications

- 1>Outline Dimension : 113.0X65.0 X 12.7 mm (See attached Outline Drawing for Deta)

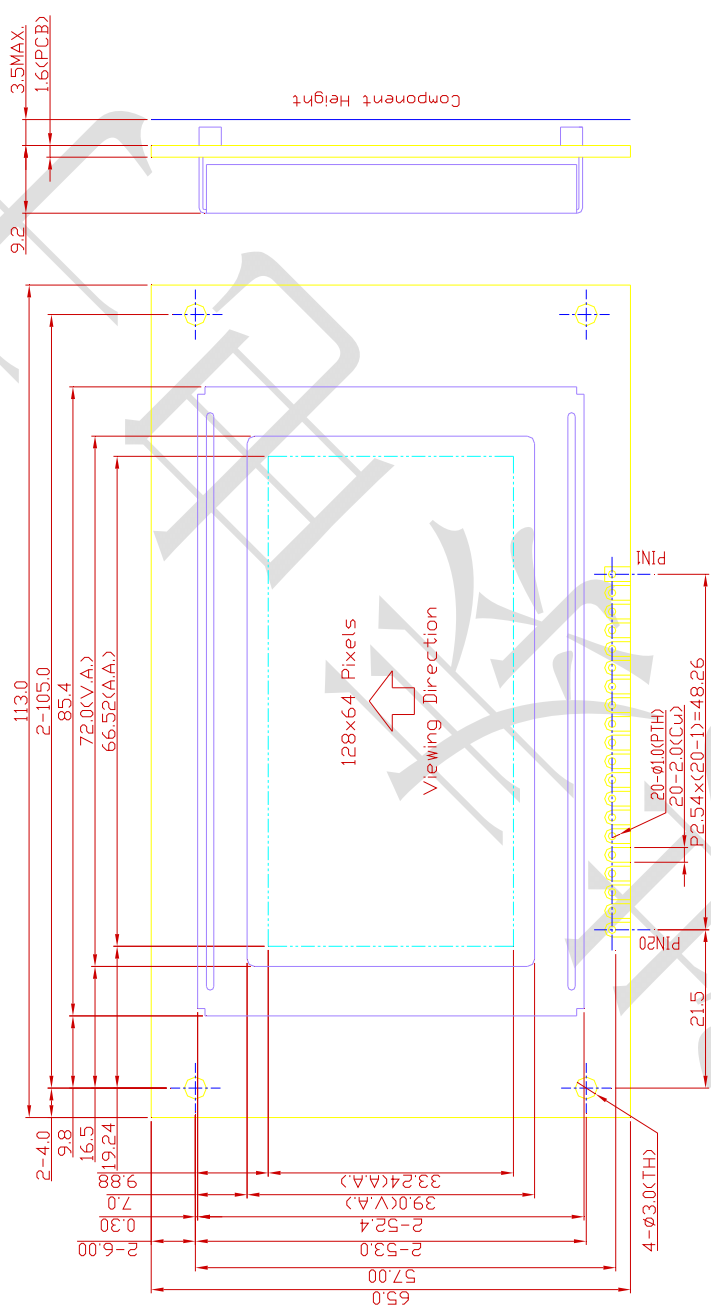

1.3 Circuit Diagram

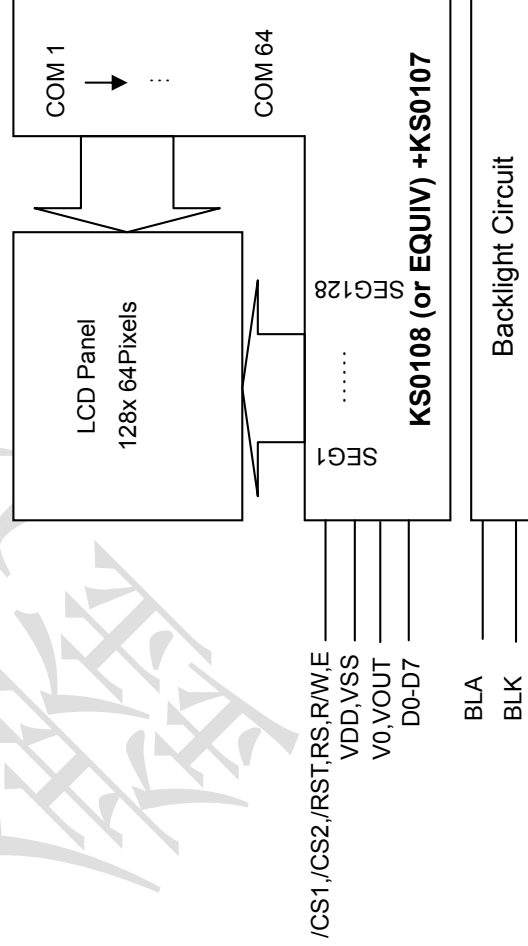



鑫洪泰

HOT DISPLAY 为您提供专业的显示解决方案

HTM12864A-25W-N5P

1.4 Terminal Function

Pin No.	Pin Name	Function
1	VSS	Power Supply Negative(0V)
2	VDD	Power Supply Positive(5.0V)
3	V0	LCM Adjust Contrast
4	RS	Data or Instruction. RS=H->DB<0:7> : Display RAM Data RS=L->DB<0:7> : Instruction Data
5	R/W	H:Read ; L: Write.
6	E	Enable signal. write mode (R/W=L) -> data of DB<0:7> is latched at the falling edge of E. read mode (R/W=H) -> DB<0:7> appears the reading data while E is at high level.
7~14	D0~D7	Data Buss
15	/CS1	Chip selection input 1(Left)
16	/CS2	Chip selection input 2(Mid)
17	/RST	Reset Signal input
18	VOUT	LCD Driver, About(-10)V
19	BLA	Backlight Positive(5.0V)
20	BLK	Backlight Negative(0V)



1.5 Product Outline

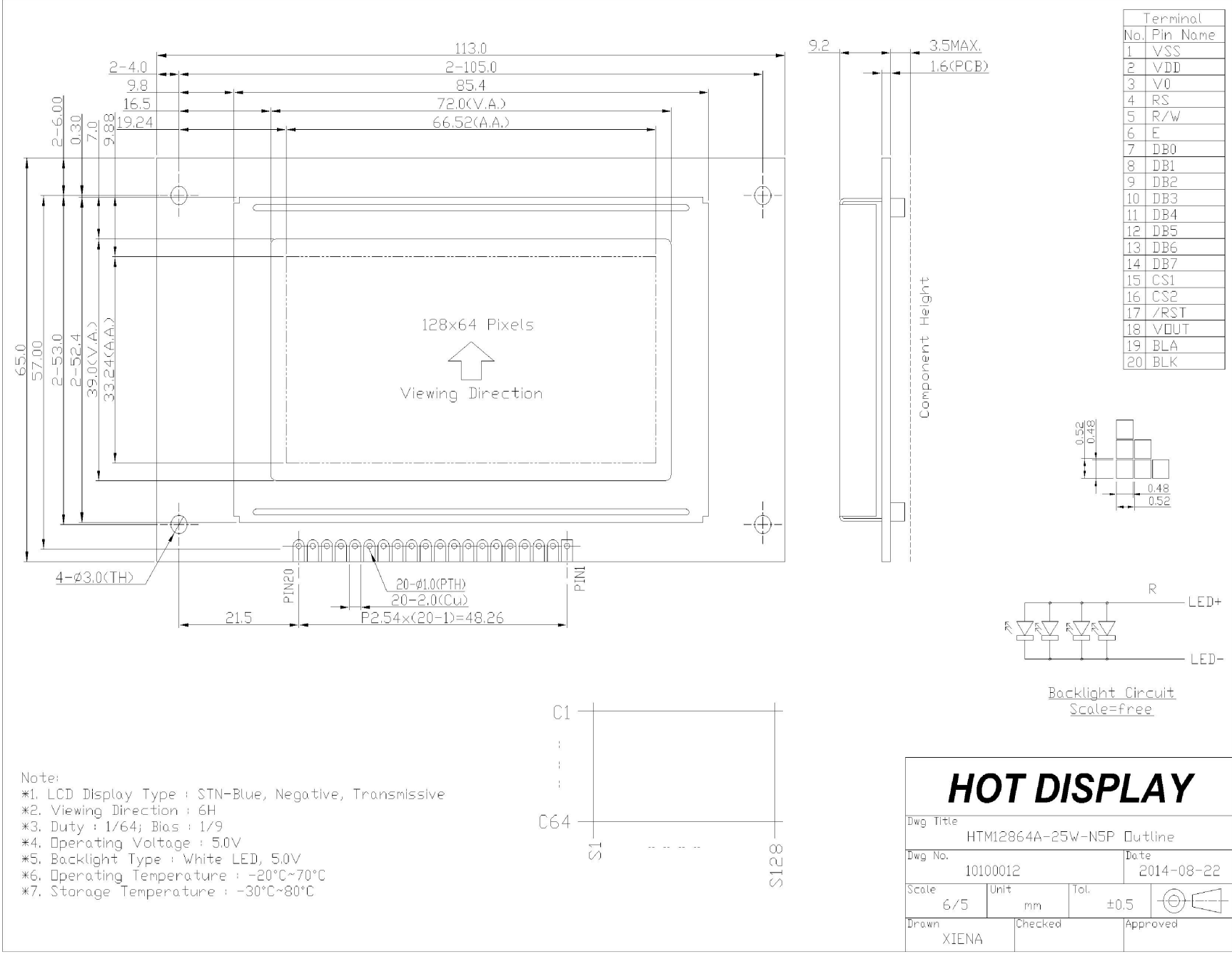

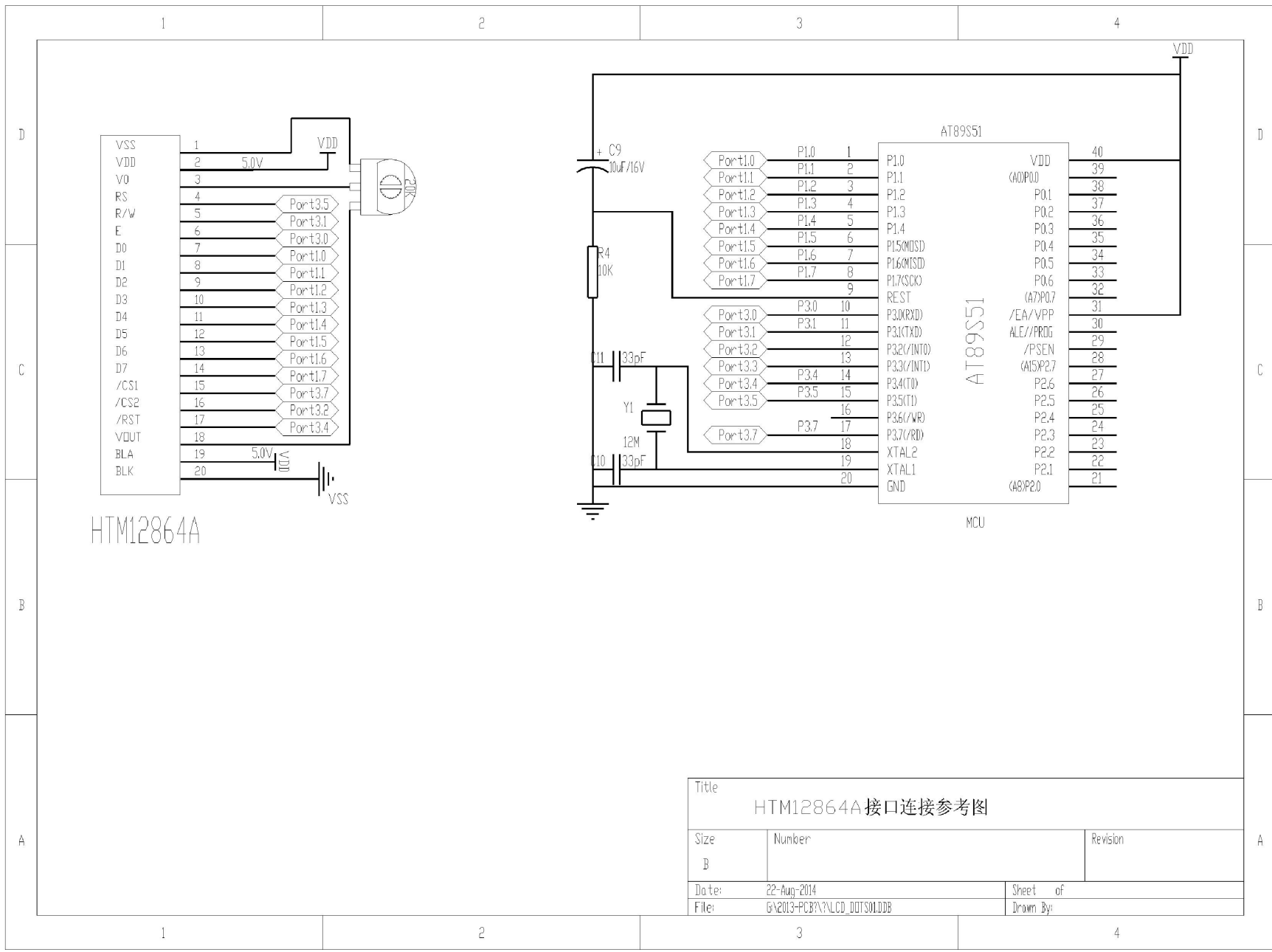
1.6 Schematic Diagram

Title		
HTM12864A 接口连接参考图		
Size	Number	Revision
B		
Date:	22-Aug-2014	Sheet of
File:	G:\2013-PCB\?\?LCD_DOTSO1.DDB	Drawn By:

2. Absolute Maximum Ratings

Items	Symbol	MIN.	MAX.	Unit	Condition
Supply Voltage	V _{DD}	-	+5.5	V	V _{SS} = 0V
Supply Voltage	V _{EE}	V _{DD} -16.0	V _{DD} +0.3	V	V _{SS} = 0V
Driver Supply Voltage	V _{LCD}	V _{EE} -0.3	V _{DD} +0.3	V	-
Operating Temperature	T _{OP}	-20	+70	°C	No Condensation
Storage Temperature	T _{st}	-30	+80	°C	No Condensation

3. Electrical Characteristics

3.1 DC Characteristics

Items	Symbol	MIN.	TYP.	MAX.	Unit	Condition
Operating Voltage	V _{DD}	4.5	5.0	5.5	V	V _{DD}
Input High Voltage	V _{IH}	2.0	-	V _{DD}	V	*1
Input Low Voltage	V _{IL}	0	-	0.8	V	
Output High Voltage	V _{OH}	2.4	-	-	V	*2
Output Low Voltage	V _{OL}	-	-	0.4	V	
Operating Current	I _{DD1}	-	2.0	3.0	mA	*3
OSC Frequency	F _{osc}	315	450	585	KHz	R _f =47K±2%

3.2 LED Backlight Circuit

Items	Symbol	MIN.	TYP.	MAX.	Unit	Condition
Forward Voltage	V _f BLA	-	5.0	-	V	Without Resistor
Forward Current	I _f BLA	-	60	65	mA	-

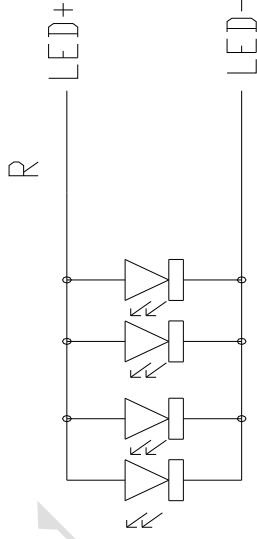

3.3 AC Characteristics

Chatacteristic	Symbol	Min	Typ	Max	Unit
E Cycle	t_c	1000	-	-	ns
E High Level Width	t_{WH}	450	-	-	ns
E Low Level Width	t_{WL}	450	-	-	ns
E Rise Time	t_R	-	-	25	ns
E Fall Time	t_F	-	-	25	ns
Address Set-Up Time	t_{ASU}	140	-	-	ns
Address Hold Time	t_{AH}	10	-	-	ns
Data Set-Up Time	t_{DSU}	200	-	-	ns
Data Delay Time	t_D	-	-	320	ns
Data Hold Time (Write)	t_{DHW}	10	-	-	ns
Data Hold Time (Read)	t_{DHR}	20	-	-	ns

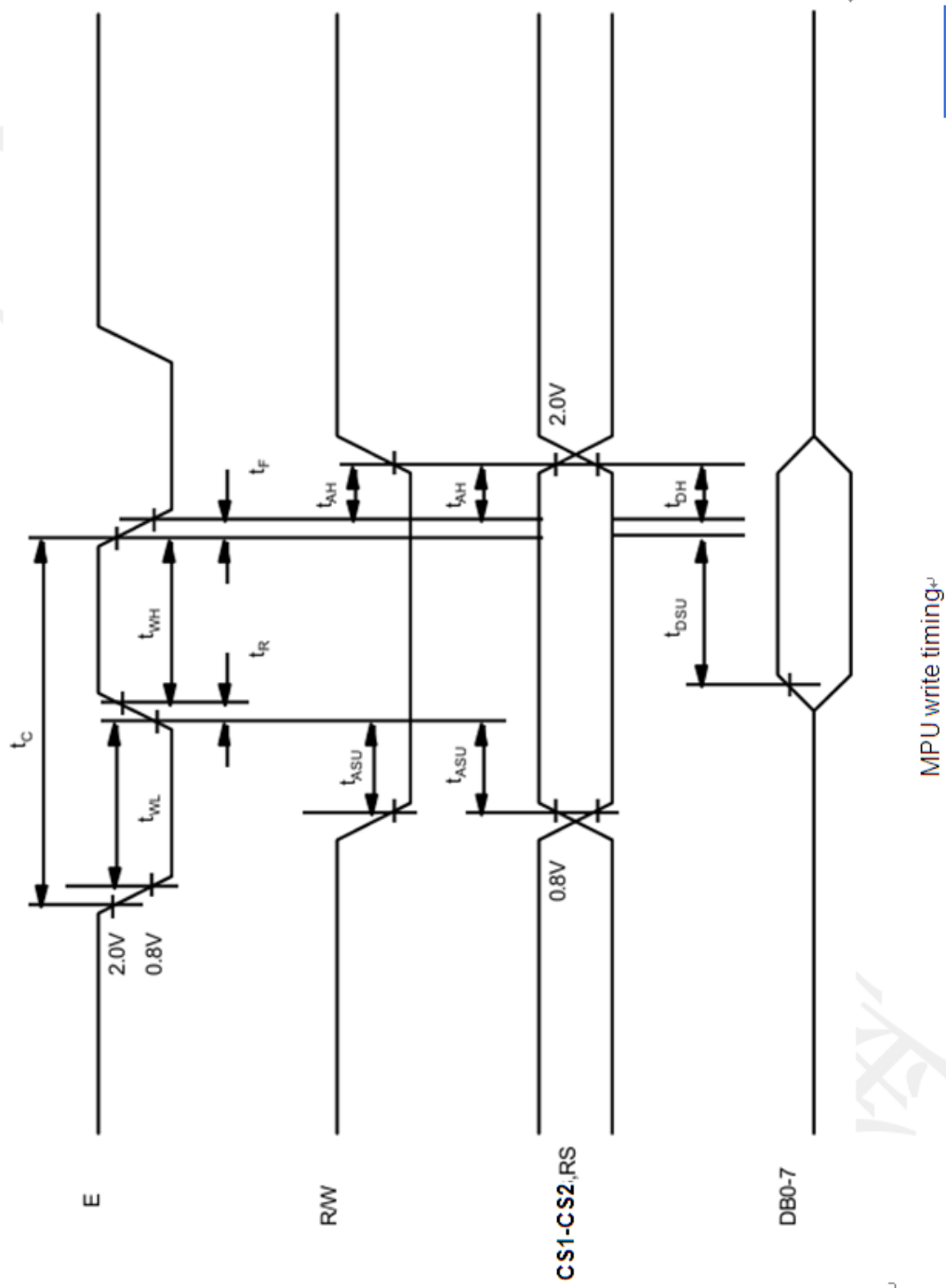

MPU write timing

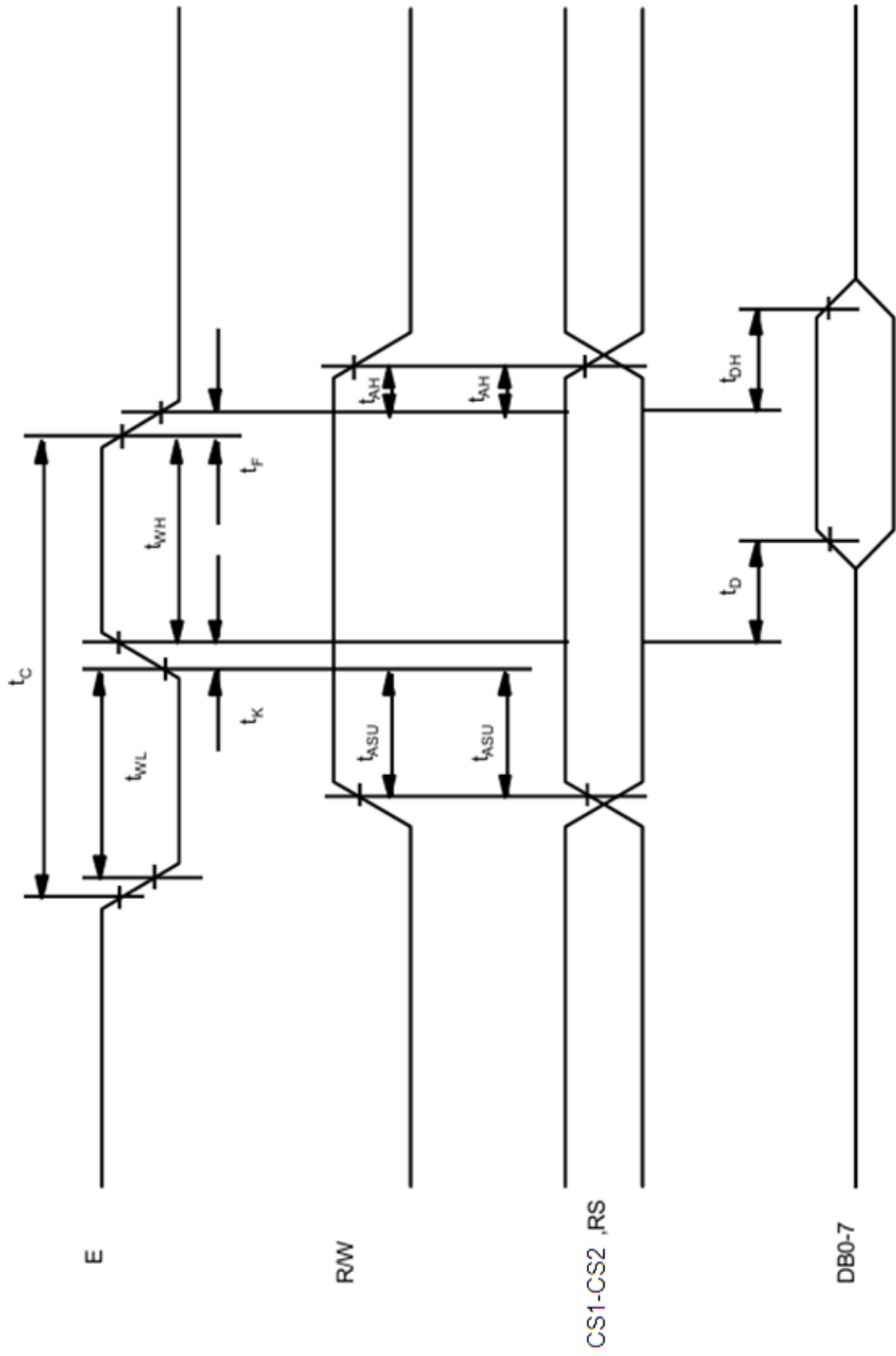
MPU read timing⁺

3.4 Rest Timing

Item	Symbol	Min	Typ	Max	Unit
Reset Time	t_{RS}	1.0	-	-	us
Rise Time	t_R	-	-	200	ns

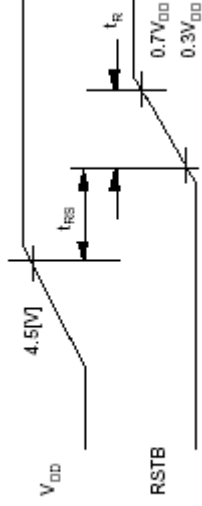

4. Function specifications

4.1 The Parallel Interface

	Area Selection		Shared	6800 Mode			Function(6800)
	/CS2	/CS1		R/W	E		
Left (0)	1	0	H	H	H	H	Reads the display data
Middle(1)	0	1	H	L	H→L	H→L	Writes the display data
Right(2)	1	1	L	H	H	H	Staus read
			L	L	H→L	H→L	Write Command data

4.2 Display Memory Map

PAGE	COL			SEG125	SEG126	SEG127
	SEG0	SEG1	SEG2			
PAGE0	D7	D7			D7	D7
PAGE1	D0	D0			D0	D0
PAGE6						
PAGE7	D7	D7			D7	D7
	D0	D0			D0	D0

Pixels:128X64

4.3 Display Commands

Instruction	RS	R/W	DB7	DB6	DB5	DB4	DB3	DB2	DB1	DB0	Function
Display ON/OFF	L	L	L	L	H	H	H	H	H	L/H	Controls the display on or off. Internal status and display RAM data is not affected. L: OFF, H: ON
Set Address	L	L	L	H	Y address (0~63)						Sets the Y address in the Y address counter.
Set Page (X address)	L	L	H	L	H	H	H	Page (0~7)			Sets the X address at the X address register.
Display Start Line	L	L	H	H	Display start line (0~63)						Indicates the display data RAM displayed at the top of the screen.
Status Read	L	H	B U S Y	L	O N / O F F	R E S E T	L	L	L	L	Read status. BUSY L: Ready H: In operation ON/OFF L: Display ON H: Display OFF RESET L: Normal H: Reset
Write Display Data	H	L	Write Data						Writes data (DB0:7) into display data RAM. After writing instruction, Y address is increased by 1 automatically.		
Read Display Data	H	H	Read Data						Reads data (DB0:7) from display data RAM to the data bus.		

Reference code

```

void Cselect()
{
if(chip_select==0)
  { CS1=0;CS2=1;CS3=1;}
if(chip_select==1)
  { CS1=1;CS2=0;CS3=1;}
if(chip_select==2)
  { CS1=1;CS2=1;CS3=0;
  }
void WrateC(uchar cmd)
{
  Cselect();
  R_S=0;
  RW=0;
  P1=cmd;
  E=1;
  E=0;
  CS1=1;CS2=1;CS3=1;
}
void WrateC(uchar page+0xB8);
void WrateC(column+0x40);

void WriteData(uchar dat
{
  Cselect();
  R_S=1;
  RW=0;
  P1=dat;
  E=1;
  E=0;
  CS1=1;CS2=1;CS3=1;
}
void Setadd(uchar
column,uchar page)
{
  if(column<64)
  chip_select=0;
  else
  {
    if(column>127)
    { chip_select=2;

```



为您提供专业的显示解决方案

HTM12864A-25W-N5P

4.4 Basic Operating Sequence Initialization Sequence

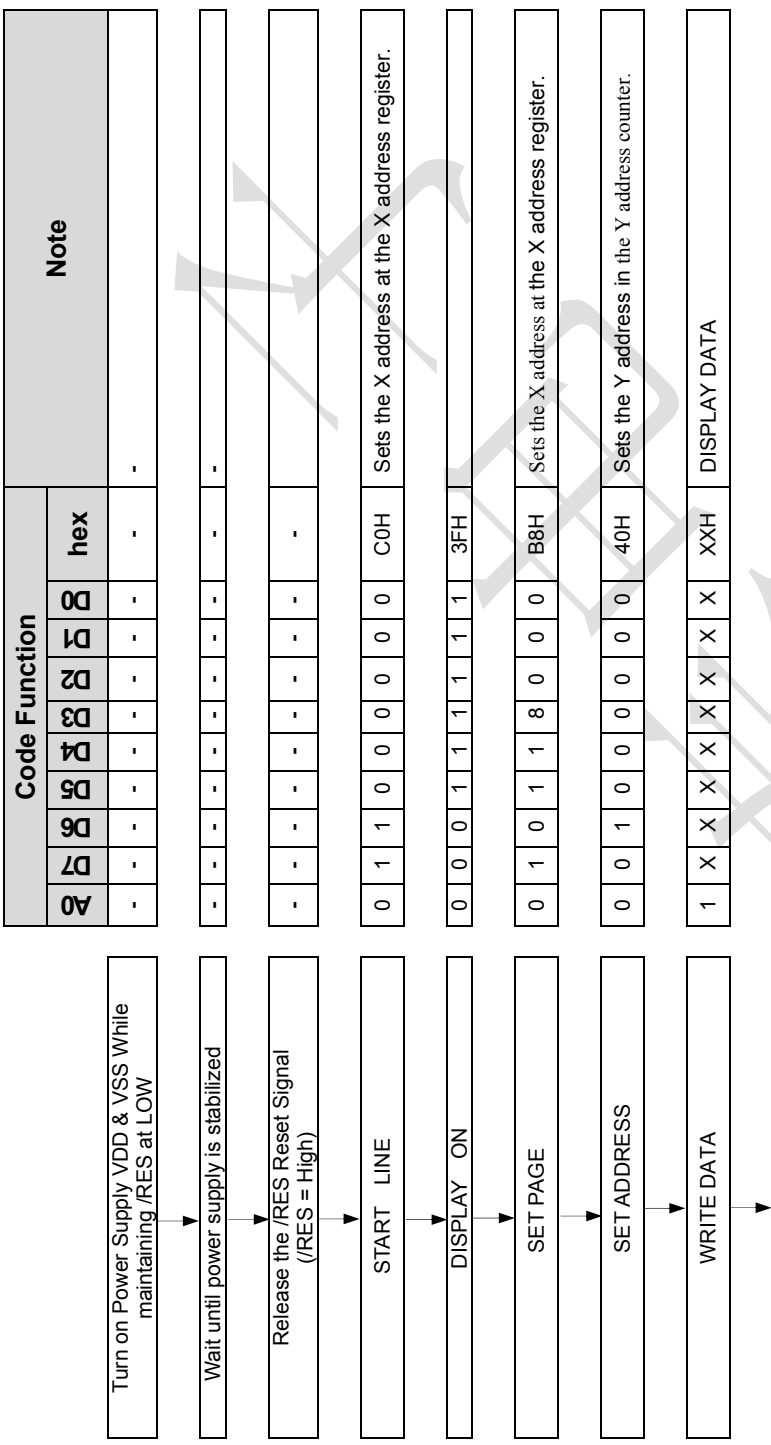

5. Inspection Standards

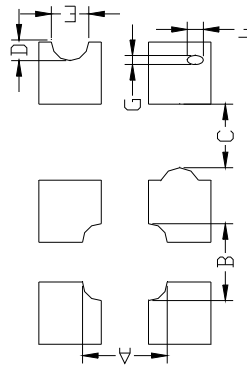
Item	Criterion for defects	Defect type
1) Display on inspection	(1) Non display (3) Horizontal line is deficient Size Φ (mm) $\Phi \leq 0.3$ $0.3 < \Phi \leq 0.45$ $0.45 < \Phi \leq 0.6$ $0.6 < \Phi$	Major
2) Black / White spot	Acceptable number Ignore (note) 3 1 0	Minor
3) Black / White line	Length (mm) Width (mm) $L \leq 10$ $W \leq 0.03$ $5.0 \leq L \leq 10$ $0.03 < W \leq 0.04$ $5.0 \leq L \leq 10$ $0.04 < W \leq 0.05$ $1.0 \leq L \leq 10$ $0.05 < W \leq 0.06$ $1.0 \leq L \leq 10$ $0.06 < W \leq 0.08$ $L \leq 10$ $0.08 < W$ Defects separate with each other at an interval of more than 20mm	Minor
4) Display pattern	 $A+B \leq 0.28$ $0 < C$ $D+E \leq 0.25$ $F+G \leq 0.25$ Note: 1) Up to 3 damages acceptable 2) Not allowed if there are two or more pinholes every three-fourth inch. Acceptable Number Ignore (note) 3 1 0 Note: 1) Conformed to limit samples. 2) Intervals of defects are more than 30mm.	Minor
5) Spot-like contrast irregularity	Size Φ (mm) $\Phi \leq 0.7$ $0.7 < \Phi \leq 1.0$ $1.0 < \Phi \leq 1.5$ $1.5 < \Phi$	Minor
6) Bubbles in polarizer	Size Φ (mm) $\Phi \leq 0.4$ $0.4 < \Phi \leq 0.65$ $0.65 < \Phi \leq 1.2$ $1.2 < \Phi$	Minor
7) Scratches and dent on the polarizer	Acceptable Number Ignore (note) 2 1 0	Minor
8) Stains on the surface of LCD panel	Scratches and dent on the polarizer shall be in the accordance with "2) Black/white spot", and "3) Black/White line". Stains which cannot be removed even when wiped lightly with a soft cloth or similar cleaning.	Minor
9) Rainbow color	No rainbow color is allowed in the optimum contrast on state within the active area.	Minor
10) Viewing area encroachment	Polarizer edge or line is visible in the opening viewing area due to polarizer shortness or sealing line.	Minor
11) Bezel appearance	Rust and deep damages that are visible in the bezel are rejected.	Minor
12) Defect of land surface contact	Evident crevices that are visible are rejected.	Minor
13) Parts mounting	(1) Failure to mount parts (2) Parts not in the specifications are mounted (3) For example: Polarity is reversed, HSC or TCP falls off.	Minor
14) Part alignment	(1) LSI, IC lead width is more than 50% beyond pad outline. (2) More than 50% of LSI, IC leads is off the pad outline.	Minor
15) Conductive foreign matter (solder ball, solder hips)	(1) $0.45 < \Phi$, $N \geq 1$ (2) $0.3 < \Phi \leq 0.45$, $N \geq 1$, Φ : Average diameter of solder ball (unit: mm) (3) $0.5 < L$, $N \geq 1$, L: Average length of solder chip (unit: mm)	Minor
16) Bezel flaw	Bezel claw missing or not bent	Minor
17) Indication on name plate (sampling indication label)	(1) Failure to stamp or label error, or not legible.(all acceptable if legible) (2) The separation is more than 1/3 for indication discoloration, in which the characters can be checked.	Minor

6. Handling Precautions

6.1 Mounting method

A panel of LCD module made by our company consists of two thin glass plates with polarizers that easily get damaged. And since the module is so constructed as to be fixed by utilizing fitting holes in the printed circuit board (PCB), extreme care should be used when handling the LCD modules.

6.2 Cautions of LCD handling and cleaning

When cleaning the display surface, use soft cloth with solvent (recommended below) and wipe lightly.

- Isopropyl alcohol
- Ethyl alcohol
- Trichlorotrifluoroethane

Do not wipe the display surface with dry or hard materials that will damage the polarizer surface.

Do not use the following solvent:

- Water
- Ketene
- Aromatics

6.3 Caution against static charge

The LCD module uses C-MOS LSI drivers. So we recommend you:

Connect any unused input terminal to V_{dd} or V_{ss} . Do not input any signals before power is turned on, and ground your body, work/assembly areas, assembly equipment to protect against static electricity.

6.4 Packaging

- Module employs LCD elements, and must be treated as such. Avoid intense shock and falls from a height.
- To prevent modules from degradation, do not operate or store them exposed direct to sunshine or high temperature/humidity.

6.5 Caution for operation

- It is an indispensable condition to drive LCD module within the limits of the specified voltage since the higher voltage over the limits may cause the shorter life of LCD module.
- An electrochemical reaction due to DC (direct current) causes LCD undesirable deterioration so that the uses of DC (direct current) drive should be avoided.
- Response time will be extremely delayed at lower temperature than the operating temperature range and on the other hand at higher temperature LCD module may show dark color in them. However those phenomena do not mean malfunction or out of order of LCD module, which will come back in the specified operating temperature.

6.6 Storage

In the case of storing for a long period of time, the following ways are recommended:

- Storage in polyethylene bag with the opening sealed so as not to enter fresh air outside in it. And with not desiccant.
- Placing in a dark place where neither exposure to direct sunlight nor light is. Keeping the storage temperature range.
- Storing with no touch on polarizer surface by any thing else.

6.7 Safety

- It is recommendable to crash damaged or unnecessary LCD into pieces and to wash off liquid crystal by either of solvents such as acetone and ethanol, which should be burned up later.
- When any liquid leaked out of a damaged glass cell comes in contact with your hands, please wash it off well at once with soap and water.

7. Packaging Specifications

		Packaging Specifications				Approved	Checked	Des-Label
		HTM12864A						
7.1 Packaging Material								
No	Item	Dimensions (mm)	IPCS Weight (KG)	Quantity	Total Weight			
1	LCM	113.0*65.0*9.2	0.090	200	18.0			
2	PE Bag	140*100	0.001	200	0.2			
3	Foam Rubber Cushion	310*170	0.0175	4	0.07			
4	Partition AI	310*200*100	0.30	4	1.2			
5	Product Box	330*180*120 (neutral packing)	0.45	4	1.8			
6	Carton	390*370*350 (neutral packing)	0.9	1	0.9			
7	Tape			AR				
8	Label Specifications			1				
9	Label Rohs			1				
10	Label ESD			1				

7.2. Total LCD Weight in carton: 22.0 KG±10%

7.3. Packaging Specifications and Quantity:

(1) Quantity Of Spacer: AI*4

(2) Total LCM quantity in carton: quantity per box 50* no of boxes 4 = 200

